



STANDARDS

The calculations are carried out in accordance with:

- Eurocode 2: Design of concrete structures. Part 1-1: General rules and rules for buildings.
- Eurocode 3: Design of steel structures. Part 1-1: General rules and rules for buildings.
- Eurocode 3: Design of steel structures. Part 1-8: Design of joints.
- EN 10080: Steel for the reinforcement of concrete. Weldable reinforcing steel. General.

For all NDPs (Nationally Determined Parameter) in the Eurocodes the recommended values are used.

NDP's are as follows:

Parameter	γ_c	γ_s	α_{cc}	α_{ct}	$C_{Rd,c}$	v_{min}	k_1
Recommended value	1.5	1.15	1.0	1.0	0.12	$0.035k^{1/3} \cdot f_{ck}^{1/2}$	0.15

Table 1: NDP-s in EC-2.

Parameter	γ_{M0}	γ_{M1}	γ_{M2}
Recommended value	1.0	1.0	1.25

Table 2: NDP-s in EC-3.

QUALITIES

Concrete grade C35/45:

$$f_{ck} = 35,0 \text{ MPa} \quad \text{EC2, Table 3.1}$$

$$f_{cd} = \alpha_{cc} \cdot f_{ck} / \gamma_c = 1 \cdot 35 / 1,5 = 23,3 \text{ MPa} \quad \text{EC2, Pt.3.15}$$

$$f_{ctd} = \alpha_{ct} \cdot f_{ctk,0,05} / \gamma_c = 1 \cdot 2,20 / 1,5 = 1,46 \text{ MPa} \quad \text{EC2, Pt.3.16}$$

$$f_{bd} = 2,25 \cdot \eta_1 \cdot \eta_2 \cdot f_{ctd} = 2,25 \cdot 0,7 \cdot 1,0 \cdot 1,46 = 2,3 \text{ MPa} \quad \text{EC2, Pt.8.4.2}$$

$$f_{ck} := 35 \cdot \text{MPa} = 5076.321 \cdot \text{psi} \quad \text{Characteristic Cylinder Strength}$$

$$f_{cd} := 1.0 \cdot \frac{f_{ck}}{1.5} = 3384.214 \cdot \text{psi} \quad \text{Design Compressive Strength}$$

$$f_{ctk0_05} := 2.2 \cdot \text{MPa} \quad \text{Characteristic axial tensile strength of concrete}$$

$$f_{ctd} := 1.0 \cdot \frac{f_{ctk0_05}}{1.5} = 212.722 \cdot \text{psi} \quad \text{Design Tensile Strength}$$

η_1 is a coefficient related to the quality of the bond condition and the position of the bar during concreting
 = 1.0 for condition of good bond
 = 0.7 for all other cases and for bars in structural elements built with slipforms

η_2 is related to bar diameter
 = 1.0 for $\phi \leq 40\text{mm}$ (NDP)
 = $(140 - \phi) / 100$ for $\phi > 40\text{mm}$

$$\eta_1 := 0.7 \quad \text{coefficient related to bond condition}$$

$$\eta_2 := 1.0 \quad \text{coefficient related to bar diameter}$$

$$d_{rb} := 0.5 \cdot \text{in} = 12.7 \cdot \text{mm} \quad \text{Use \#4 Rebar}$$

$$f_{bd} := 2.25 \cdot \eta_1 \cdot \eta_2 \cdot f_{ctd} = 335.037 \cdot \text{psi} \quad \text{Design Bond Stress}$$



Reinforcement B500C:

$$f_{yd} = f_{yk} / \gamma_s = 500 / 1,15 = 435 \text{ MPa}$$

EC2, Pt.3.2.7

$$f_{yd} := 500 \frac{\text{MPa}}{1,15} = 63059,886 \cdot \text{psi}$$

Design Yield Strength of Reinforcement

Structural steel S355:

Tension: $f_{yd} = f_y / \gamma_{M0} = 355 / 1,0 = 355 \text{ MPa}$

Compression: $f_{yd} = f_y / \gamma_{M0} = 355 / 1,0 = 355 \text{ MPa}$

Shear: $f_{sd} = f_y / (\gamma_{M0} \cdot \sqrt{3}) = 355 / (1,0 \cdot \sqrt{3}) = 205 \text{ MPa}$

$$f_{yd_ts} := 355 \frac{\text{MPa}}{1,0} = 51488,397 \cdot \text{psi}$$

Design Tension Stress of Tube Steel

$$f_{yd_ts} := 355 \frac{\text{MPa}}{1,0} = 51488,397 \cdot \text{psi}$$

Design Compression Stress of Tube Steel

$$f_{sd_ts} := 355 \frac{\text{MPa}}{1,0 \cdot \sqrt{3}} = 29726,84 \cdot \text{psi}$$

Design Shear Stress of Tube Steel

DIMENSIONS

Inner tube: HUP 100x50x6, Cold formed, S355

Outer tube: HUP 120x60x4, Cold formed, S355

LOADS

Vertical ultimate limit state load = $F_v = 100 \text{ kN}$.

$$F_v := 100 \cdot \text{kN} = 22,481 \cdot \text{kip}$$

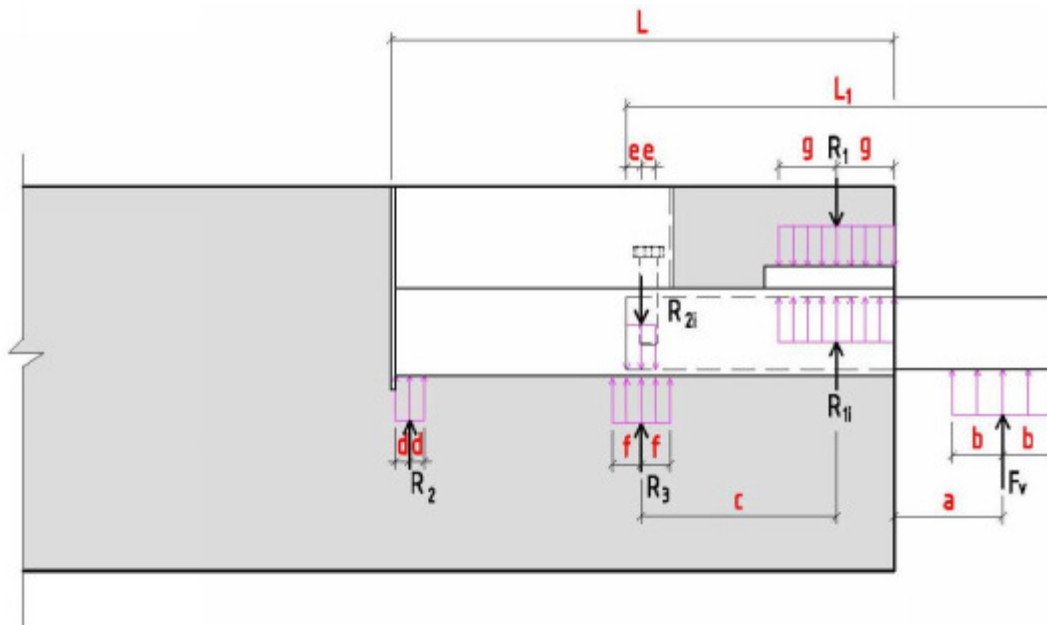

Figure 1: Forces acting on the unit.

F_v = External force on the inner tube

R_{1i}, R_{2i} = Internal forces between the inner and outer tubes.

R_1, R_2, R_3 = Support reaction forces the outer tube.

g = distance to the middle plane of the anchoring stirrups in front of the unit.

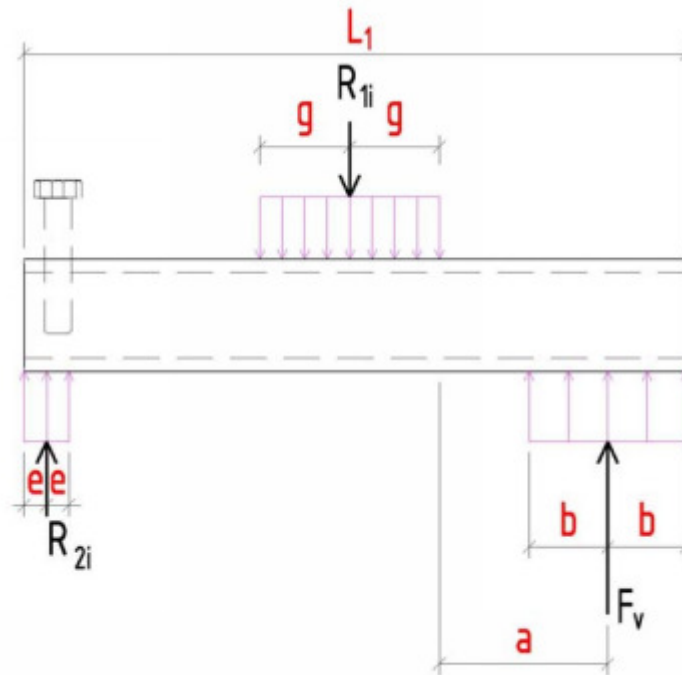

Figure 2: Forces acting on the inner tube.

Equilibrium equations of the inner tube:

$$\begin{aligned} 1): \sum M=0: & \quad F_v \cdot (L_1 - b - e) - R_{1i} \cdot (L_1 - b - a - g - e) = 0 \\ 2): \sum F_y=0: & \quad F_v - R_{1i} + R_{2i} = 0 \end{aligned}$$

Assuming Nominal Values:

$$L_1 := 295 \text{ mm} \quad a := 75 \text{ mm} \quad b := 35 \text{ mm} \quad g := 40 \text{ mm} \quad e := 10 \text{ mm}$$

$$L_1 = 11.614 \text{ in} \quad a = 2.953 \text{ in} \quad b = 1.378 \text{ in} \quad g = 1.575 \text{ in} \quad e = 0.394 \text{ in}$$

Results:

$$R_{1i} = \frac{100 \text{ kN} \cdot (295 - 35 - 10) \text{ mm}}{(295 - 35 - 75 - 40 - 10) \text{ mm}} = 185.2 \text{ kN}$$

$$R_{2i} = 185.2 \text{ kN} - 100 \text{ kN} = 85.2 \text{ kN}$$

$$R_{1i} := \frac{F_v \cdot (L_1 - b - e)}{(L_1 - b - a - g - e)} \quad R_{1i} = 185.185 \text{ kN} \quad R_{1i} = 41.631 \text{ kip}$$

$$R_{2i} := R_{1i} - F_v \quad R_{2i} = 85.185 \text{ kN} \quad R_{2i} = 19.15 \text{ kip}$$

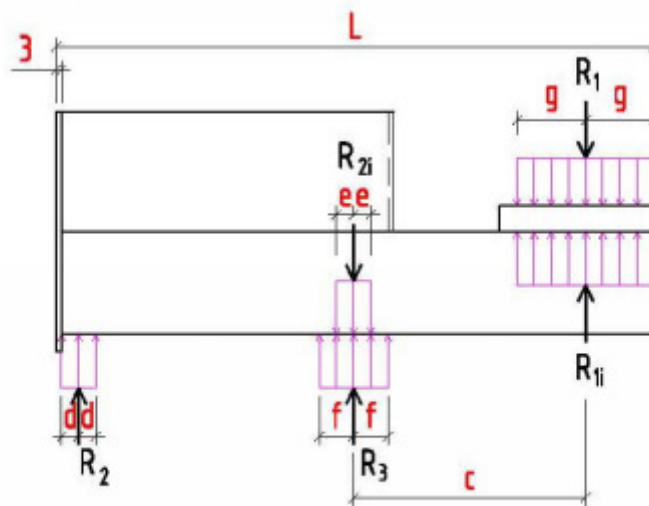

Figure 3 Forces acting on the outer tube.

Exact distribution of forces depends highly on the behavior of the outer tube. Both longitudinal bending stiffness and local transverse bending stiffness in the contact points between the inner and the outer tubes affects the equilibrium. Two situations are considered:

1) Rigid outer tube.

Outer tube rotates as a stiff body. This assumption gives minimum reaction force at R_1 , and maximum reaction force at R_2 . R_3 becomes zero. (The force R_3 will actually be negative, but since no reinforcement to take the negative forces is included at this position, it is assumed to be zero.)

Equilibrium equations of the outer tube:

$$1): \sum M=0: (R_{1i}-R_1) \cdot (L-3-g-d) - (R_{2i}-R_3) \cdot (L-3-g-c-d)=0 \quad (5)$$

$$2): \sum F_y=0: R_2+R_3+R_{1i}-R_{2i}-R_1=0 \quad (6)$$

Assuming Nominal Values:

$$L := 348 \text{ mm} \quad c := L_1 - b - a - g - e = 135 \text{ mm} \quad g := 40 \text{ mm} \quad e := 10 \text{ mm} \quad d := 10 \text{ mm}$$

$$L = 13.701 \text{ in} \quad c = 5.315 \text{ in} \quad g = 1.575 \text{ in} \quad e = 0.394 \text{ in} \quad d = 0.394 \text{ in}$$

Assume $R_{31} := 0$ kip per discussion above

$$(185.2 - R_1) \cdot (348 - 3 - 40 - 10) - (85.2 - 0) \cdot (348 - 3 - 40 - 135 - 10) = 0$$

$$54634 - 295R_1 - 13632 = 0$$

$$R_1 = \frac{41002}{295} = 139 \text{ kN}$$

Given

$$(R_{1i} - R_1) \cdot (L - 3 \text{ mm} - g - d) - (R_{2i} - R_3) \cdot (L - 3 \text{ mm} - g - c - d) = 0$$

$$R_{11} := \text{Find}(R_1) \quad R_{11} = 138.983 \text{ kN} \quad R_{11} = 31.245 \text{ kip}$$

$$R_2 = R_1 + R_{2i} - R_{1i} - R_3 = 139 + 85.2 - 185.2 = 39 \text{ kN}$$

$$R_{21} := R_{11} + R_{2i} - R_{1i} - R_{31} \quad R_{21} = 38.983 \text{ kN} \quad R_{21} = 8.764 \text{ kip}$$



2) Outer tube without bending stiffness. No forces transferred to outer tube at the back of inner tube.

This assumption gives maximum reaction forces R_1 and R_3 . R_2 becomes zero. The forces follow directly from the assumption: $R_1 = R_{1i}$ $R_3 = R_{2i}$ and $R_2 = 0$

$$R_1 = 185.2 \text{ kN}$$

$$R_2 = 0 \text{ kN}$$

$$R_3 = 85.2 \text{ kN}$$

$$R_{1_2} := R_{1i} \quad R_{1_2} = 185.185 \text{ kN} \quad R_{1_2} = 41.631 \text{ kip}$$

$$R_{2_2} := 0 \text{ kip}$$

$$R_{3_2} := R_{2i} \quad R_{3_2} = 85.185 \text{ kN} \quad R_{3_2} = 19.15 \text{ kip}$$

The magnitude of the forces will be somewhere in between the two limits, and the prescribed reinforcement ensures integrity for both situations. Reinforcement is to be located at the assumed attack point for support reactions.

Use Maximum Reactions considering both assumptions

$$R_1 := \max(R_1) \quad R_1 = 185.185 \text{ kN} \quad R_1 = 41.631 \text{ kip}$$

$$R_2 := \max(R_2) \quad R_2 = 38.983 \text{ kN} \quad R_2 = 8.764 \text{ kip}$$

$$R_3 := \max(R_3) \quad R_3 = 85.185 \text{ kN} \quad R_3 = 19.15 \text{ kip}$$

Reinforcement Necessary to anchor the unit to concrete

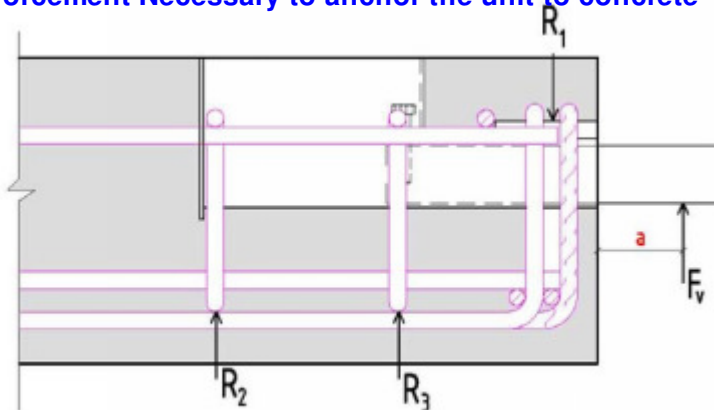

Figure 4: Forces.

Eurocode Equations

Reinforcement for $R_1 = 185.185 \text{ kN}$

$$\text{Reinforcement } R_1: A_{s1} = R_1 / f_{sd} = 185.2 \text{ kN} / 435 \text{ MPa} = 426 \text{ mm}^2$$

$$\text{Select } 2-\emptyset 12 = 2 \times 2 \times 113 = 452 \text{ mm}^2$$

$$\text{Capacity selected reinforcement: } R = 452 \text{ mm}^2 \cdot 435 \text{ MPa} = 196.6 \text{ kN}$$

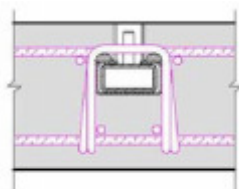

$$A_{s1} := \frac{R_1}{f_{yd}} \quad A_{s1} = 425.926 \text{ mm}^2$$

Bar Size

$$\text{size}_{\text{metric}} := 12$$

Bars Required

$$N_{\text{reqd}} := \text{ceil} \left(\frac{A_{s1}}{A_{\text{rb_metric}} \cdot \text{size}_{\text{metric}}^2} \right)$$

$$N_{\text{reqd}} = 2$$

Capacity of Supplied Reinforcing

$$N_{\text{reqd}} \cdot (A_{\text{rb_metric}} \cdot \text{size}_{\text{metric}}^2 \cdot f_{yd}) = 196.522 \text{ kN}$$

**Reinforcement for** $R_3 = 85.185 \text{ kN}$

Reinforcement R_3 : $A_{s3} = R_3 / f_{sd} = 85.2 \text{ kN} / 435 \text{ MPa} = 196 \text{ mm}^2$

Select 1- $\emptyset 12 = 1 \times 2 \times 113 = 226 \text{ mm}^2$

Capacity selected reinforcement: $R = 226 \text{ mm}^2 \cdot 435 \text{ MPa} = 98.3 \text{ kN}$

$$A_{s3} := \frac{R_3}{f_{yd}} \quad A_{s3} = 195.926 \text{ mm}^2$$

Bar Size

size_{metric} := 12

Bars Required
$$N_{\text{reqd}} := \text{ceil} \left(\frac{A_{s3}}{A_{\text{rb_metric}} \cdot \text{size}_{\text{metric}}^2} \right)$$

N_{reqd} = 1

Capacity of Supplied Reinforcing
$$N_{\text{reqd}} \cdot (A_{\text{rb_metric}} \cdot \text{size}_{\text{metric}}^2 \cdot f_{yd}) = 98.261 \text{ kN}$$

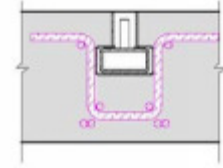
**Reinforcement for** $R_2 = 38.983 \text{ kN}$

Reinforcement R_2 : $A_{s2} = R_2 / f_{sd} = 39 \text{ kN} / 435 \text{ MPa} = 89 \text{ mm}^2$

Select 1- $\emptyset 12 = 1 \times 2 \times 113 = 226 \text{ mm}^2$

Capacity selected reinforcement: $R = 226 \text{ mm}^2 \cdot 435 \text{ MPa} = 98.3 \text{ kN}$

$$A_{s2} := \frac{R_2}{f_{yd}} \quad A_{s2} = 89.661 \text{ mm}^2$$

Bar Size

size_{metric} := 12

Bars Required
$$N_{\text{reqd}} := \text{ceil} \left(\frac{A_{s2}}{A_{\text{rb_metric}} \cdot \text{size}_{\text{metric}}^2} \right)$$

N_{reqd} = 1

Capacity of Supplied Reinforcing
$$N_{\text{reqd}} \cdot (A_{\text{rb_metric}} \cdot \text{size}_{\text{metric}}^2 \cdot f_{yd}) = 98.261 \text{ kN}$$

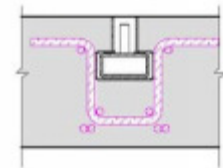
**US equivalent Equations****Reinforcement for** $R_1 = 41.631 \text{ kip}$ **Rebar Yield Strength**

$f_y := 60 \text{ ksi}$

Strength Reduction Factor for rebar in tension

$\phi_t := 0.9$

$$A_{s1} := \frac{R_1}{\phi_t \cdot f_y} \quad A_{s1} = 0.771 \text{ in}^2$$

Bar Size

size := 4

Bars Required

$$N_{\text{reqd}} := \text{ceil} \left(\frac{A_{s1}}{A_{\text{rb_size}} \cdot \text{size}^2} \right)$$

N_{reqd} = 2

Capacity of Supplied Reinforcing

$$N_{\text{reqd}} \cdot [A_{\text{rb_size}} \cdot \text{size}^2 \cdot (\phi_t \cdot f_y)] = 43.2 \text{ kip}$$

Reinforcement for $R_3 = 19.15 \text{ kip}$ **Rebar Yield Strength**

$f_y := 60 \text{ ksi}$

Strength Reduction Factor for rebar in tension

$\phi_t := 0.9$

$$A_{s3} := \frac{R_3}{\phi_t \cdot f_y} \quad A_{s3} = 0.355 \text{ in}^2$$

Bar Size

size := 4

Bars Required

$$N_{\text{reqd}} := \text{ceil} \left(\frac{A_{s3}}{A_{\text{rb_size}} \cdot \text{size}^2} \right)$$

N_{reqd} = 1

Capacity of Supplied Reinforcing

$$N_{\text{reqd}} \cdot [A_{\text{rb_size}} \cdot \text{size}^2 \cdot (\phi_t \cdot f_y)] = 21.6 \text{ kip}$$

Reinforcement for $R_2 = 8.764 \text{ kip}$ **Rebar Yield Strength**

$f_y := 60 \text{ ksi}$

Strength Reduction Factor for rebar in tension

$\phi_t := 0.9$

$$A_{s2} := \frac{R_2}{\phi_t \cdot f_y} \quad A_{s2} = 0.162 \text{ in}^2$$

Bar Size

size := 4

Bars Required

$$N_{\text{reqd}} := \text{ceil} \left(\frac{A_{s2}}{A_{\text{rb_size}} \cdot \text{size}^2} \right)$$

N_{reqd} = 1

Capacity of Supplied Reinforcing

$$N_{\text{reqd}} \cdot [A_{\text{rb_size}} \cdot \text{size}^2 \cdot (\phi_t \cdot f_y)] = 21.6 \text{ kip}$$



Customer: _____ Job No.: _____ Date: 10.2.18

7131 North Ridgeway Ave.
Lincolnwood, Illinois 60712
1-800-742-8127
www.jvi-inc.com

Subject: RVK 101 Tube Steel Verification

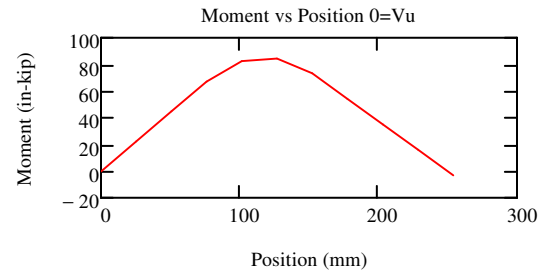
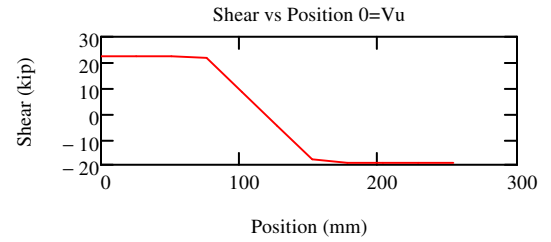
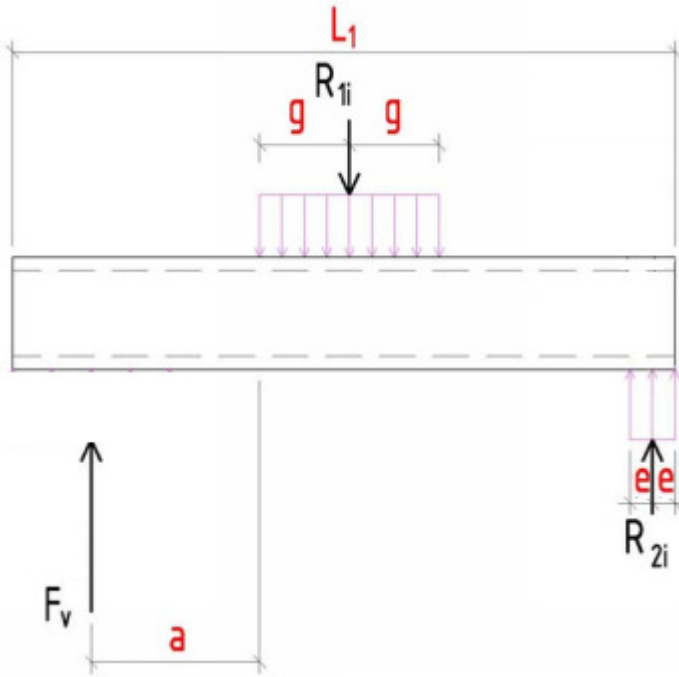

Width $W_{inTube} := 100\text{-mm}$ Thickness $t_{in} := 6\text{-mm}$
 Height $H_{inTube} := 50\text{-mm}$ Height $d_{in} := H_{inTube}$
 Tube Steel Yield Strength $F_{yts} := 50\text{-ksi}$

Eurocode Equations

Shear Capacity of Tube Steel

Ultimate Shear

$$\phi V_{ts} := f_{sd_ts} \cdot 2 \cdot t_{in} \cdot (d_{in})$$

$$F_v = 100\text{-kN}$$

$$F_v = 22.481\text{-kip}$$

$$\phi V_{ts} = 122.976\text{-kN}$$

$$\phi V_{ts} = 27.646\text{-kip}$$

Moment Capacity of Tube Steel

Ultimate Moment @ Location of zero shear

$$\text{ZeroShear} := \text{root}(V_u(X), X) \quad \text{ZeroShear} = 4.654\text{-in} \quad M_{u_zero} := |M_u(\text{ZeroShear})| \quad M_{u_zero} = 85.498\text{-in-kip}$$

Supplied Plastic Section Modulus

$$Z_{supplied} := 29200\text{-mm}^3$$

$$Z_{supplied} = 1.782\text{-in}^3$$

$$\phi M_p := f_{yd_ts} \cdot Z_{supplied}$$

$$\phi M_p = 91.747\text{-in-kip}$$

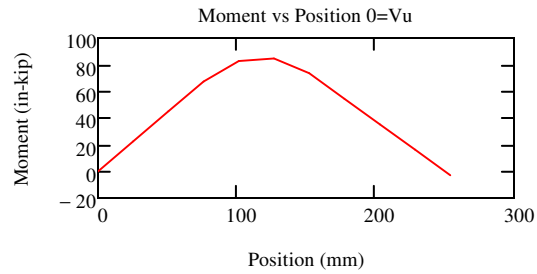
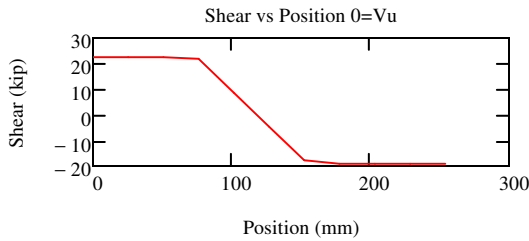

US equivalent Equations

Shear Capacity of Tube Steel

Ultimate Shear

$$F_v = 22.481 \text{ kip}$$

$$F_v = 100 \text{ kN}$$

$$F_v = 22.481 \text{ kip}$$

$$\phi V_{TS} := 0.9 \cdot 0.6 \cdot F_{yTS} \cdot 2 \cdot t_{in} \cdot (d_{in})$$

$$\phi V_{TS} = 111.695 \text{ kN}$$

$$\phi V_{TS} = 25.11 \text{ kip}$$

Moment Capacity of Tube Steel

Ultimate Moment @ Location of zero shear

$$\text{ZeroShear} := \text{root}(V_u(X), X) \quad \text{ZeroShear} = 4.654 \text{ in}$$

$$M_{u_zero} := |M_u(\text{ZeroShear})| \quad M_{u_zero} = 85.498 \text{ in} \cdot \text{kip}$$

Supplied Plastic Section Modulus

$$Z_{\text{supplied}} = 1.782 \text{ in}^3$$

$$\phi M_p := 0.9 \cdot F_{yTS} \cdot Z_{\text{supplied}}$$

$$\phi M_p = 80.185 \text{ in} \cdot \text{kip}$$

Plastic Section Modulus not satisfied for US Code Equivalent, reduce Design Strength to

$$F_v := 21.3 \text{ kip}$$

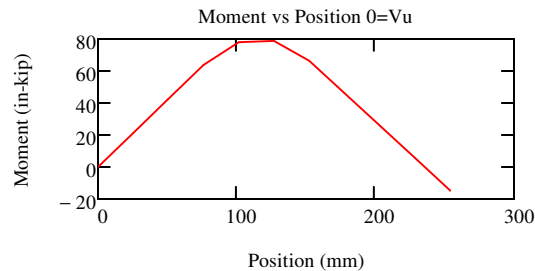
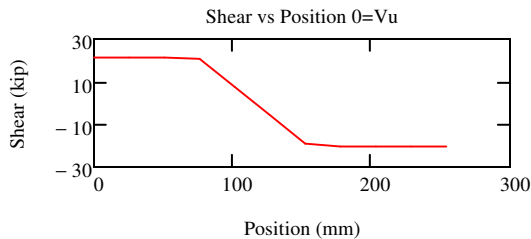

Moment Capacity of Tube Steel

Ultimate Moment @ Location of zero shear

$$\text{ZeroShear} := \text{root}(V_u(X), X) \quad \text{ZeroShear} = 4.564 \text{ in}$$

$$F_v = 94.747 \text{ kN}$$

$$F_v = 21.3 \text{ kip}$$

$$M_{u_zero} := |M_u(\text{ZeroShear})|$$

$$M_{u_zero} = 80.056 \text{ in} \cdot \text{kip}$$

Supplied Plastic Section Modulus

$$Z_{\text{supplied}} = 1.782 \text{ in}^3$$

$$\phi M_p := 0.9 \cdot F_{yTS} \cdot Z_{\text{supplied}}$$

$$\phi M_p = 80.185 \text{ in} \cdot \text{kip}$$

The information in the worksheet has been prepared in accordance with recognized engineering principles. This information should not be used for any specific application without competent, professional examination and verification of its suitability and applicability by a licensed professional engineer, designer or architect. JVI, for themselves and their respective agents and employees, disclaim any and all implied warranties, without limitation and particularly that of fitness for any general or particular purpose or freedom from infringement of any patent, trademark, or copyright in regard to information contained or referred herein. Nothing contained herein shall be construed as granting a license, express or implied, under any patents or copyright.